

# MODEL: LTOW5030 L/R

# ESCAPE

SHOWN WITH OPTIONAL THREE PIECE WALL SURROUND AND DECK EXTENSION

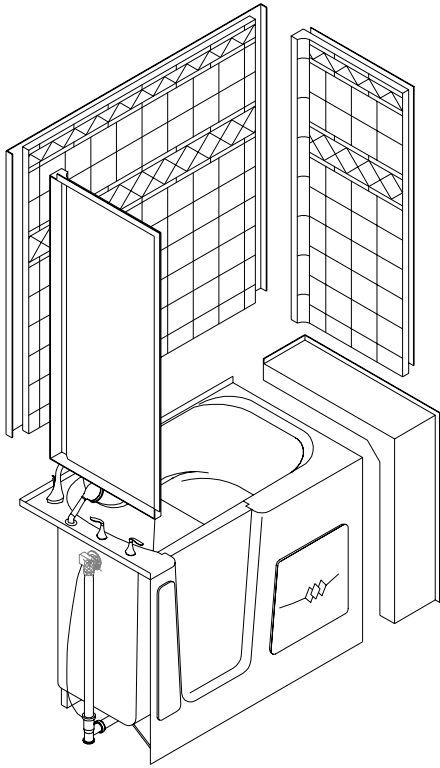

**PERSPECTIVE VIEW - N.T.S.**  
**MODEL SHOWN HERE AS:**  
**LEFT HAND**

## Features:

- Designed to fit in the space of your current bathtub
- Seat height is designed for ease of sitting and standing
- Extra deep for a full body soak
- Innovative new door handle designed for easy operation
- Reliable door seal that comes with a lifetime warranty
- Heated seat for comfort while draining
- Tile Look Wall surround system with integral plywood backing and SnapJoint for quick assembly
- Allows you the freedom to rehabilitate at home
- Space under tub allows for "reverse" plumbing.

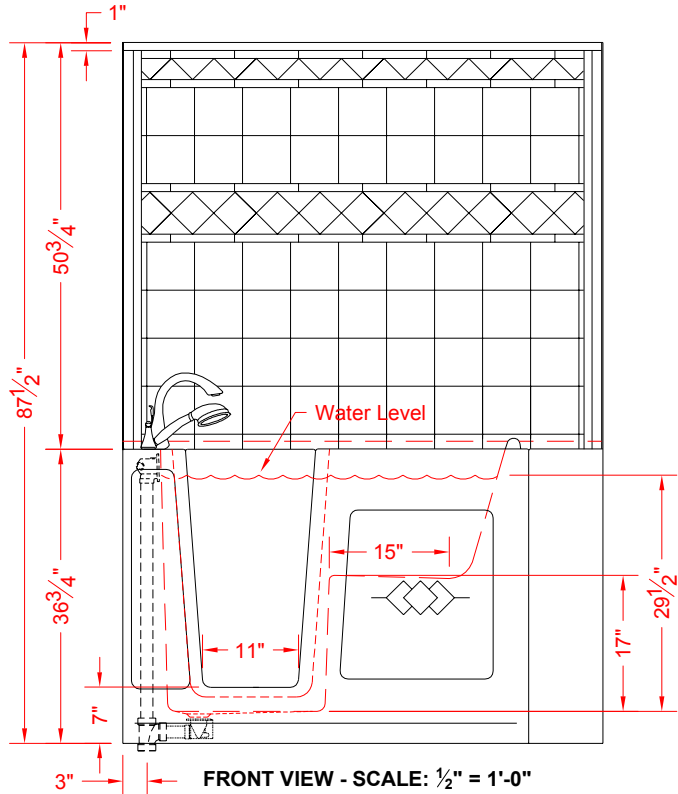
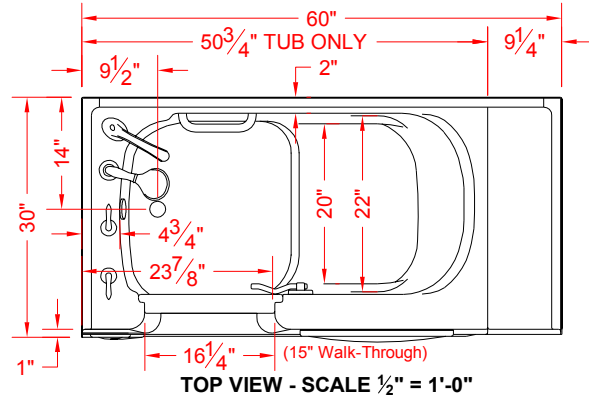

## PRODUCT SPECIFICATIONS:

- Walk-in bathtub with pressure sealed door shall be of gelcoat / fiberglass construction and have an integral front skirt, magnetically attached access panels for plumbing and deck/skirt extension.
  - The matching wall system shall have integral plywood backing and a SnapJoint assembly feature.
- C.S.I. FORMAT SPECIFICATION TEXT AVAILABLE

## CODES:

- Designed and manufactured in compliance with the following standards and codes:
- CSA B45.5-11 / A.N.S.I. Z124-2011 Plastic Plumbing Fixtures
  - ASME A112.19.15 Bathtubs/Whirlpool Bathtubs with pressure sealed doors

## PRODUCT INFORMATION:

- Accessories: Factory installed Tub Bar and optional plumbing rough-in, all others installed by others
- Colors: White as standard, Almond optional
- Also available with sprayable solid surface in many colors
- Fill volume with a 170 lbs. bather: 60 gallons
- Tub weight, dry, approx. 165 lbs.
- Shipping wt. 233 lbs.
- Total weight of tub, bather, and water: approx. 731 lbs.

**Power Requirements:**  
 Heated Seat 120V/15A (draws 0.2A)

## ACCESSORIES:

- STANDARD:**
- Tub bar
  - Cable operated tub drain
- OPTIONAL:**
- Roman tub filler
  - Hand shower
  - Thermostatic mixing valve
  - Grab bars for installation on wall surround
  - Custom Tile Accenting on Wall
  - Window trim kit
  - Flange trim kit



DIV. OF FIBERGLASS SYSTEMS INC.  
 www.best-bath.com 1-800-727-9907

*We reserve the right to make revisions without notice in the design of fixtures or in packaging unless this right has specifically been waived at the time the order is accepted.*

# ESCAPE / ESCAPE PLUS WALK-IN BATHTUB CONFIGURATIONS AVAILABLE:

①

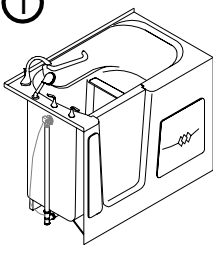

- No additional accessories included.

②

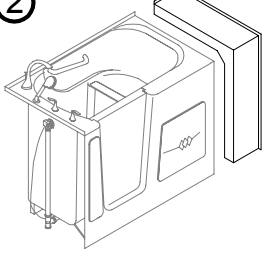

- With Deck Extension
- Fits in the space of a typical 5 ft. bathtub or shower
- Generally for an ALCOVE installation.

Escape Deck Extension  
Model # ESC-1000 (RH) / ESC-1001 (LH)

③

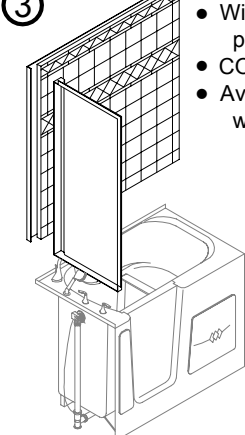

- With two walls: a back wall and a plumbing side wall.
- CORNER installation
- Available for all standard configurations with a Universal\*\* wall system.

\*\* Universal  
Model # 2DWSU6030 L/R

④

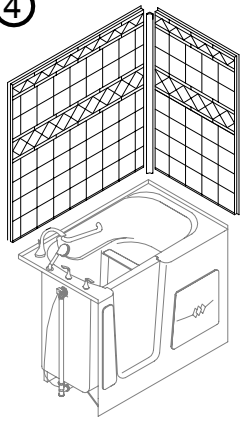

- With two walls: a back wall and an opposite plumbing side wall.
- Reverse CORNER installation
- Available for custom configurations with a Universal\*\* wall system.
- This configuration requires an add-on nailing flange.

\*\* Universal  
Model # 2DWSU6030 L/R

⑤

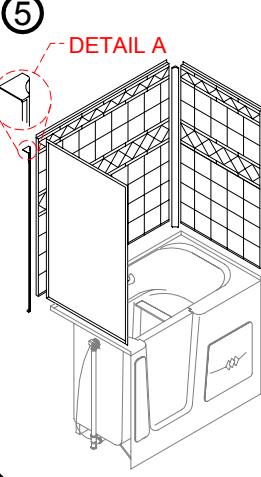

- With three walls: a back wall and two side walls.
- ALCOVE installation for a framing pocket of 50-3/4" x 30"
- Available for custom configurations or new construction in the Universal\*\* wall system only.
- This configuration requires an add-on nailing flange.

\*\* Universal  
Model # 3DWSU6030

⑥

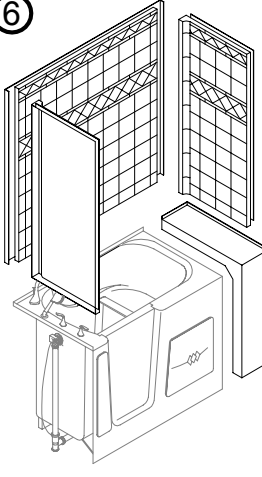

- With Deck Extension and three walls: a back wall and two side walls.
- ALCOVE installation for a framing pocket of 60" x 30"
- Available for all standard configurations in both SnapJoint\* and Universal\*\* wall systems.

\* SnapJoint  
Model # 3WIDWS6030  
\*\* Universal  
Model # 3DWSU6030  
Escape Deck Extension  
Model # ESC-1000 (RH) / ESC-1001 (LH)

- \*SnapJoint Wall System:
- Standard wall system for square framing
  - Quick, easy "snap-in" installation

- \*\*Universal Wall System (including Corner Trim: DETAIL A in option # 5) can be cut to accommodate:
- Options # 3, 4, and 5
  - Any configuration with out-of-square walls or framing
  - Other unusual situations



*We reserve the right to make revisions without notice in the design of fixtures or in packaging unless this right has specifically been waived at the time the order is accepted.*