

# MODEL: XES6337E1B\*

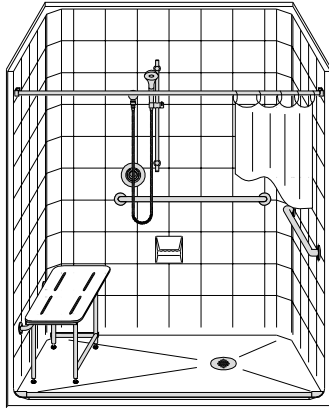

SEE OVER



**PERSPECTIVE VIEW - N.T.S.  
MODEL SHOWN HERE AS:  
LEFT SEAT  
LEFT PLUMBING  
RIGHT DRAIN**

ALL ACCESSORIES OPTIONAL

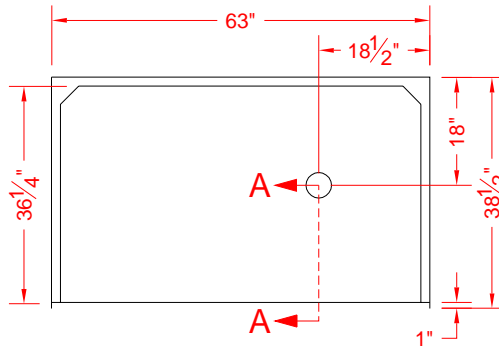

TOP VIEW - SCALE  $\frac{3}{8}'' = 1'-0''$

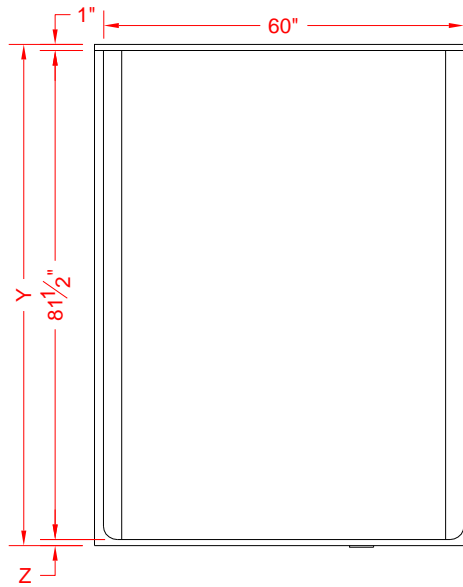

FRONT ELEVATION - SCALE:  $\frac{3}{8}'' = 1'-0''$

## Features:

- ADA compliant roll-in shower
- Available in various threshold heights
- Molded, one piece gelcoat/fiberglass shower module
- "Eight Inch Tile" wall finish, white (standard)
- Integral full wood backing for strength and unlimited accessory placement
- On all threshold heights 1-1/2" or taller, no mud set is required
- On all threshold heights 1-1/4" or shorter, no mud set is required and an anchoring adhesive kit is supplied

## \*OTHER THRESHOLD HEIGHTS AVAILABLE UPON REQUEST

MODEL #	UNIT HEIGHT	THRESHOLD HEIGHT
XES6337E1B	Y	Z*
XES6337E2B	83-1/2"	1" MIN.
	84-1/2"	2" MAX.

\* - SEE BACK FOR DETAIL SECTIONS

## PRODUCT SPECIFICATIONS:

- One piece shower module shall be constructed of gelcoat/fiberglass with full integral plywood backing
- Rough-In: Stud opening +1/4" -0" Nominal Dimensions.

C.S.I. FORMAT SPECIFICATION TEXT AVAILABLE

### PRODUCT INFORMATION:

- Accessories: Factory installed, unless prone to damage during installation/shipping. Polished chrome/satin stainless standard, others available.
- Colors: White as standard, others to match any major fixture manufacturer, also available with sprayable solid surface in many colors
- Custom curb heights, other than shown, are available (between min. and max.)

### ACCESSORIES:

#### INSTALLED AT FACTORY:

- Grab bar
- Seat, folding
- Mixing valve, pressure balanced, lever handle, pre-plumbed tree to supply elbow
- Soap dish

#### INSTALLED BY OTHERS:

- Curtain and rod
- T-Shaped Rubber WaterStopper Kit
- Semi-permanent Threshold Adaptor
- Caulkless drain

### CODES:

- Designed and manufactured in compliance with the following standards and codes:
- A.N.S.I. Z124.2 Standards for Plastic Showers
  - I.P.C. International Plumbing Code
  - A.D.A. Accessibility Guidelines for Buildings and Facilities
  - A.N.S.I. A117.1 Accessible and Usable Buildings and Facilities
  - U.P.C. Uniform Plumbing Code

### NOTICE OF LIMITATION:

- Recess as needed to meet code
- Adhere to floor as required



BEST BATH SYSTEMS INC.  
www.best-bath.com 1-800-727-9907

*We reserve the right to make revisions without notice in the design of fixtures or in packaging unless this right has specifically been waived at the time the order is accepted.*

**XES6337E1B**

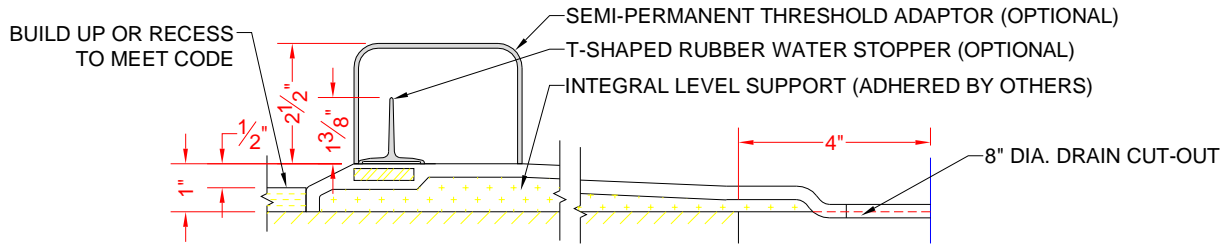

**SECTION A-A - SCALE: 3" = 1'-0"**

**XES6337E2B**

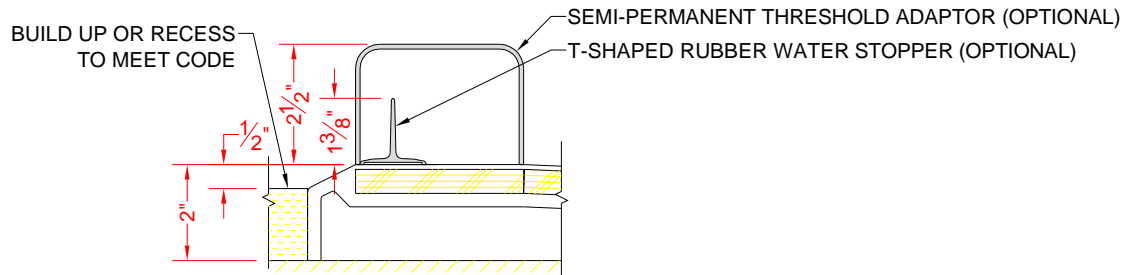

**SECTION A-A - SCALE: 3" = 1'-0"**

**\*\*OTHER THRESHOLD HEIGHTS AVAILABLE UPON REQUEST\*\***

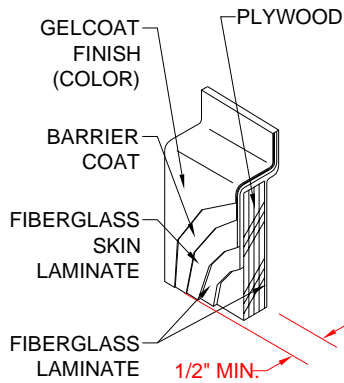

**DETAIL B - SCALE: 3" = 1'-0"**  
**WALL SECTION DETAIL**

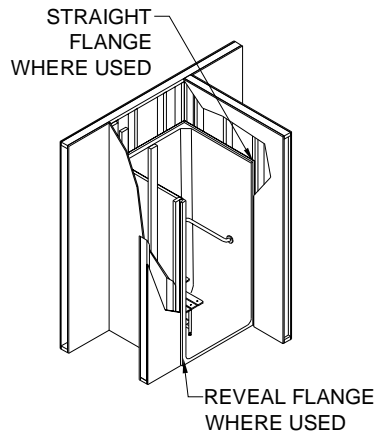

**DETAIL C - SCALE: NTS**  
**TYPICAL FRAMING**